

PRODUKTÜBERSICHT *PRODUCT OVERVIEW*

Hirt-Line[®]

**Kleines System 1/4 Zoll
(Durchlass 5,8 mm)**

**Small System 1/4 Inch
(Outlet 5,8 mm)**



Gesamtübersicht / Overview Typ 1 System 1/4"

Maschinenadapter / Machine Adapter

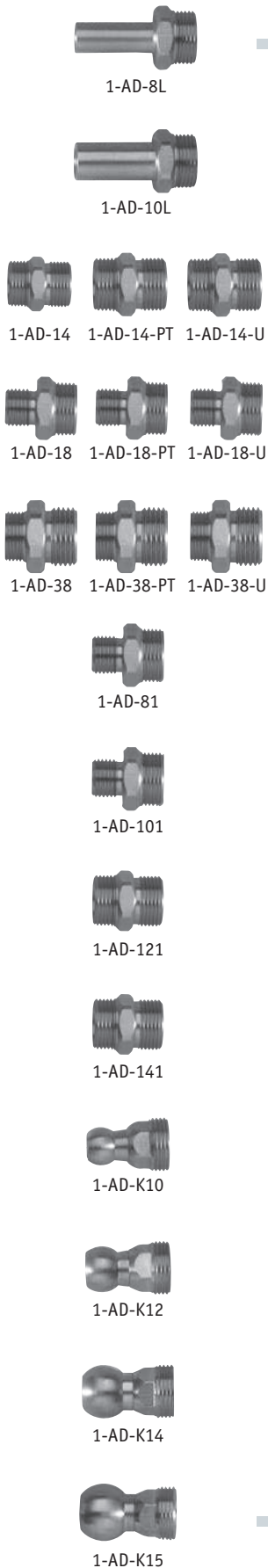

Grundelemente / Basic Elements

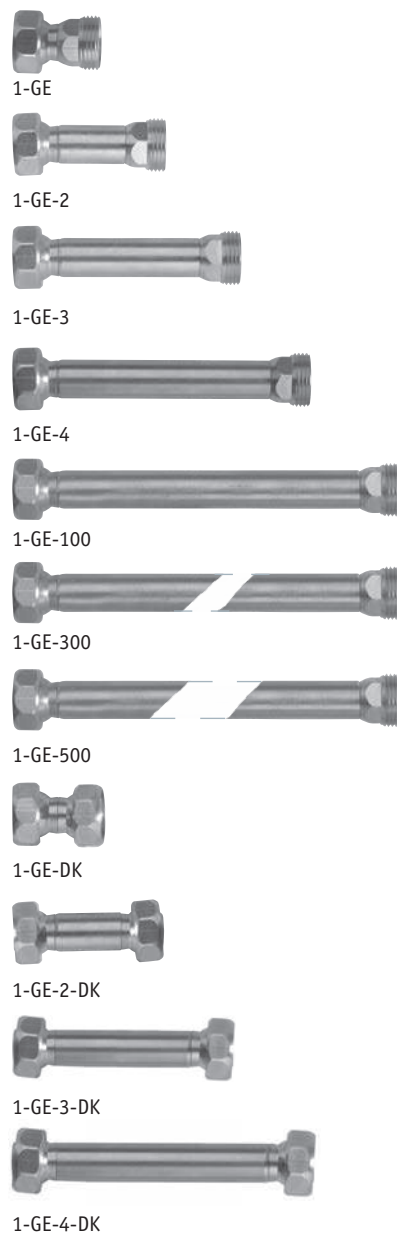

Winklelemente / Elbows



Düsen / Nozzles



Grundelemente / Basic Elements



1-GE

$l=21,5$ mm effektiv $l=18,7$ mm
 $l=21,5$ mm effective $l=18,7$ mm

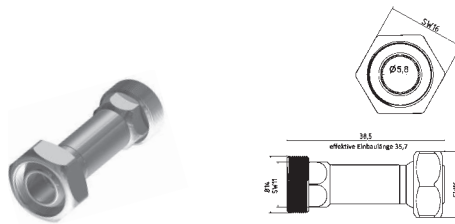

1-GE-2

$l=38,5$ mm effektiv $l=35,7$ mm
 $l=38,5$ mm effective $l=35,7$ mm

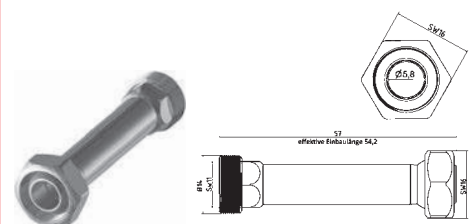

1-GE-3

$l=57$ mm effektiv $l=54,2$ mm
 $l=57$ mm effective $l=54,2$ mm

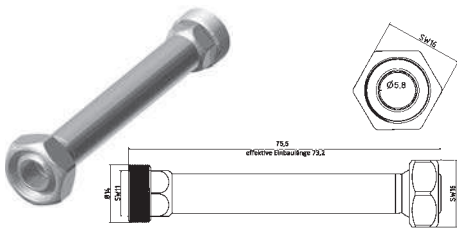

1-GE-4

$l=75,5$ mm effektiv $l=73,7$ mm
 $l=75,5$ mm effective $l=73,7$ mm



1-GE-DK

$l=22$ mm effektiv $l=18,7$ mm Doppelkugel
 $l=22$ mm effective $l=18,7$ mm double ball

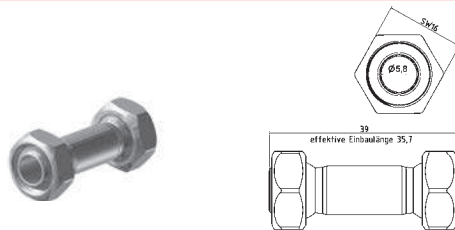

1-GE-2-DK

$l=39$ mm effektiv $l=35,7$ mm Doppelkugel
 $l=39$ mm effective $l=35,7$ mm double ball

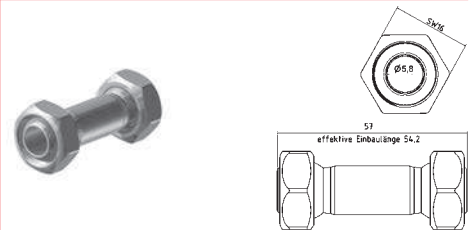

1-GE-3-DK

$l=57$ mm effektiv $l=54,2$ mm Doppelkugel
 $l=57$ mm effective $l=54,2$ mm double ball

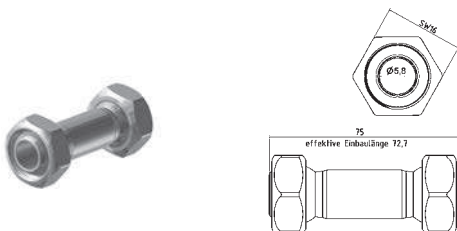

1-GE-4-DK

$l=75$ mm effektiv $l=72,7$ mm Doppelkugel
 $l=75$ mm effective $l=72,7$ mm double ball

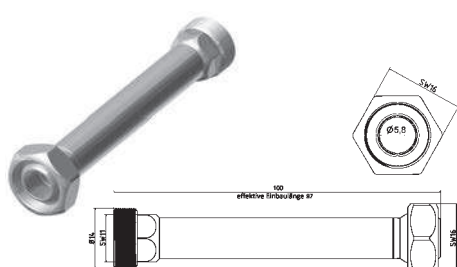

1-GE-100

$l=100$ mm effektiv $l=97$ mm
 $l=100$ mm effective $l=97$ mm

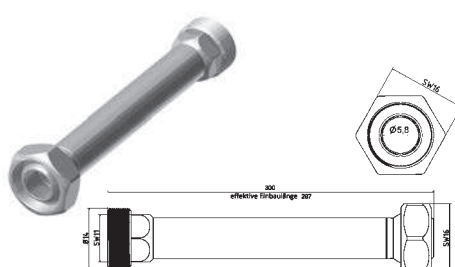

1-GE-300

$l=300$ mm effektiv $l=297$ mm
 $l=300$ mm effective $l=297$ mm

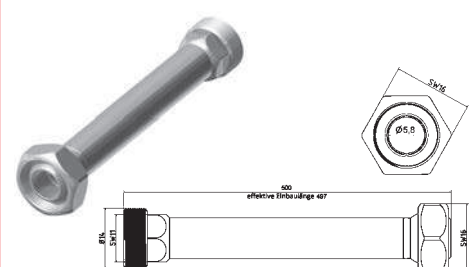

1-GE-500

$l=500$ mm effektiv $l=497$ mm
 $l=500$ mm effective $l=497$ mm

Maschinenadapter / Machine Adapter

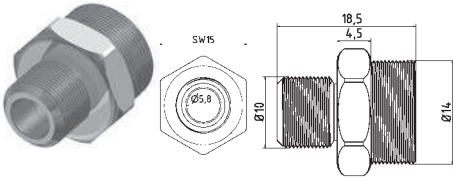

1-AD-18

Adapterstück G 1/8"

adaptor piece thread 1/8"

1-AD-18-PT

Adapterstück G 1/8" PT (Withworth-Gewinde)

adaptor piece thread 1/8" PT (NPT thread)

1-AD-18-U

Adapterstück G 1/8" U
(Gewinde unterschritten)

*adaptor piece thread 1/8" U
(Undercut thread)*

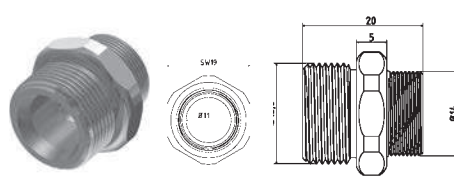

1-AD-38

Adapterstück G 3/8"

adaptor piece thread 3/8"

1-AD-38-PT

Adapterstück G 3/8" PT (Withworth-Gewinde)

adaptor piece thread 3/8" PT (NPT thread)

1-AD-38-U

Adapterstück G 3/8" U
(Gewinde unterschritten)

*adaptor piece thread 3/8" U
(Undercut thread)*

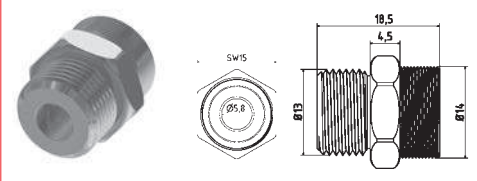

1-AD-14

Adapterstück G 1/4"

adaptor piece thread 1/4"

1-AD-14-PT

Adapterstück G 1/4" PT (Withworth-Gewinde)

adaptor piece thread 1/4" PT (NPT thread)

1-AD-14-U

Adapterstück G 1/4" U
(Gewinde unterschritten)

*adaptor piece thread 1/4" U
(Undercut thread)*

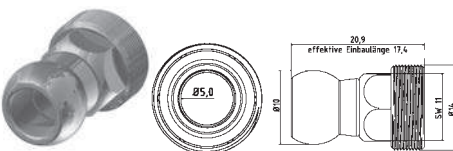

1-AD-K10

Adapterstück Kugel Ø 10 (z.B. Traub)

adaptor piece ball Ø 10 mm (e.g. Traub)

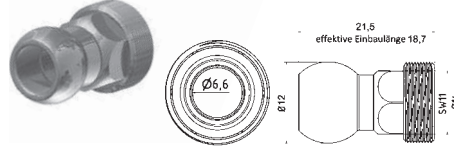

1-AD-K12

Adapterstück Kugel Ø 12 (z.B. MORI SEIKI)

adaptor piece ball Ø 12 mm (e.g. MORI SEIKI)

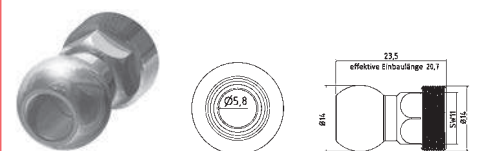

1-AD-K14

Adapterstück Kugel Ø 14 (z.B. Wenk)

adaptor piece ball Ø 14 mm (e.g. Wenk)

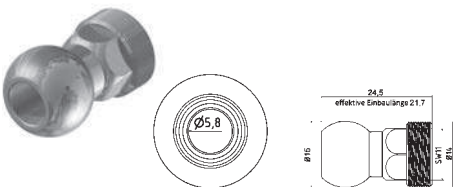

1-AD-K15

Adapterstück Kugel Ø 15 (z.B. Okuma)

adaptor piece ball Ø 15 mm (e.g. Okuma)

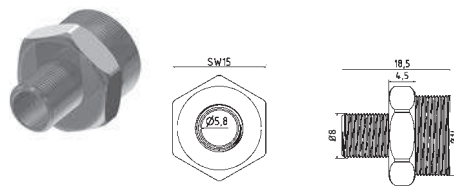

1-AD-81

Adapterstück M8 x 1

adaptor piece M8x1 metric thread

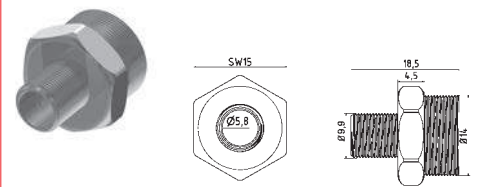

1-AD-101

Adapterstück M10 x 1

adaptor piece M10x1 metric thread

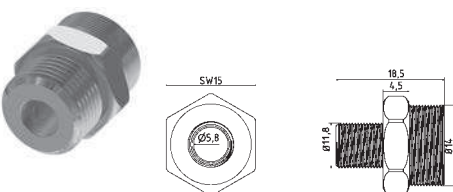

1-AD-121

Adapterstück M12 x 1

adaptor piece M12x1 metric thread

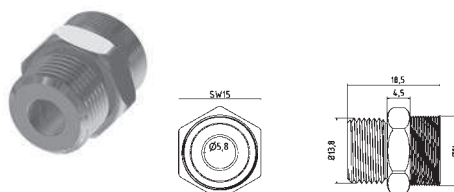

1-AD-141

Adapterstück M14 x 1

adaptor piece M14x1 metric thread

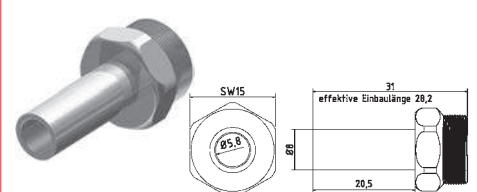

1-AD-8L

Adapterstück zu Hydraulik-Verschraubung 8 L

adaptor piece to hydraulic system 8 L

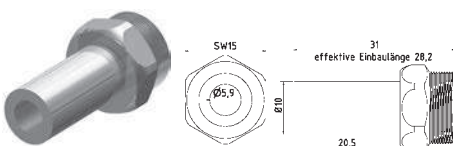

1-AD-10L

Adapterstück zu Hydraulik-Verschraubung 10 L

adaptor piece to hydraulic system 10 L

Winkelemente / Elbows

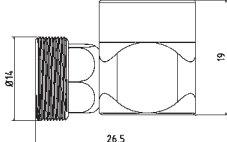
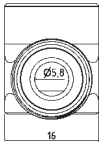

1-WV-1

Winkerverschraubung
elbow piece fixed

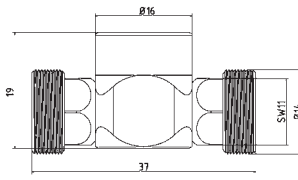
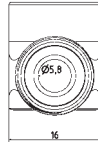

1-WV-2

T-Stück
T-piece fixed

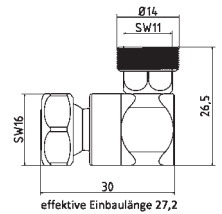
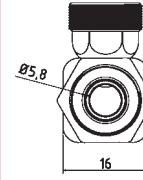

1-WV-1K

Winkerverschraubung mit Kugelstück
elbow piece moveable

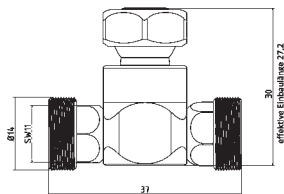
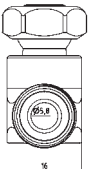
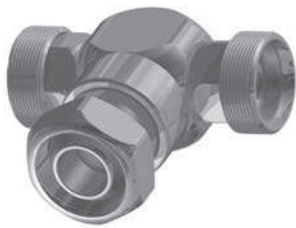

1-WV-2K

T-Stück mit Kugelstück
T-piece moveable

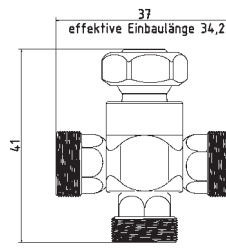
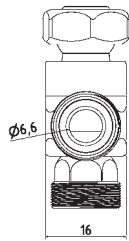

1-WV-3K

Kreuz-Stück mit Kugelstück
cross piece moveable

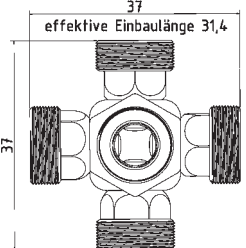
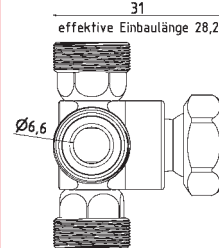

1-WV-4K

Stern-Stück mit Kugelstück
star piece moveable

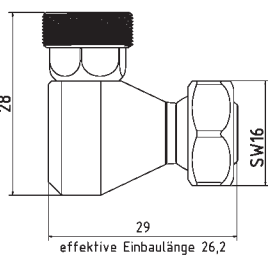
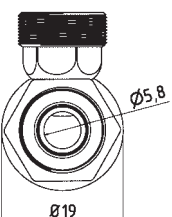

1-WI

Winkelstück für Leitungen
corner piece for pipelines

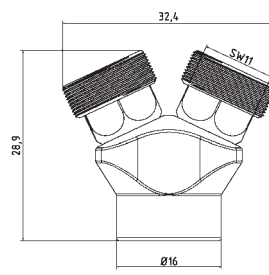
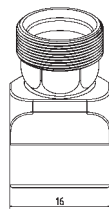

1-YV

Y-Stück 50°
Y-piece 50°

Düsen / Nozzles

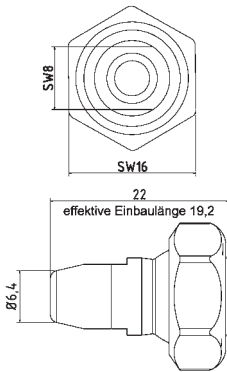

1-DU-0

Düse ohne Bohrung
nozzle straight without drilling

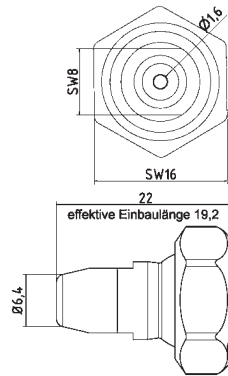

1-DU-16

Düse gerade Bohrung $\varnothing 1,6$ mm
nozzle straight $\varnothing 1,6$ mm

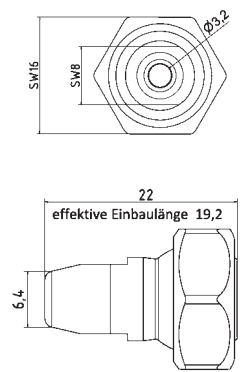

1-DU-32

Düse gerade Bohrung $\varnothing 3,2$ mm
nozzle straight $\varnothing 3,2$ mm

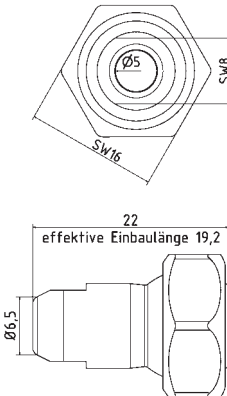

1-DU-50

Düse gerade Bohrung $\varnothing 5,0$ mm
nozzle straight $\varnothing 5,0$ mm

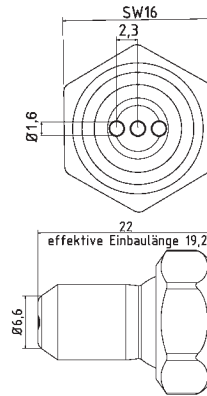

1-DU-3-16

Düse gerade Bohrung $3 \times \varnothing 1,6$ mm
nozzle straight $3 \times \varnothing 1,6$ mm

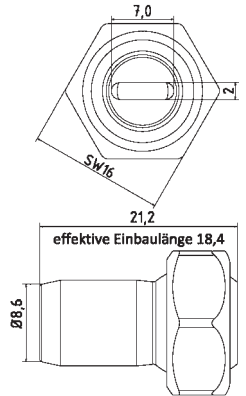

1-DU-72

Düse mit Schlitz $7 \times 2,0$ mm
nozzle straight with slit $7 \times 2,0$ mm

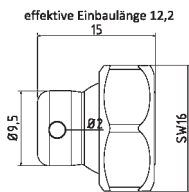

1-DU-90-1

Düse 90° Bohrung $1 \times \varnothing 2$ mm
nozzle 90° drill hole $1 \times \varnothing 2$ mm

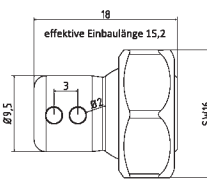

1-DU-90-2

Düse 90° Bohrung $2 \times \varnothing 2$ mm
nozzle 90° drill hole $2 \times \varnothing 2$ mm

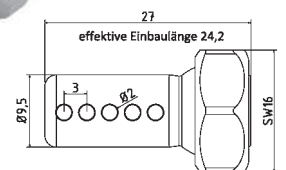

1-DU-90-5

Düse 90° Bohrung $5 \times \varnothing 2$ mm
nozzle 90° drill hole $5 \times \varnothing 2$ mm

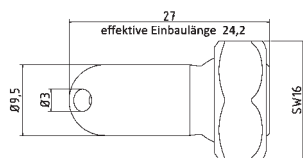

1-DU-30

Düse 30° Bohrung $\varnothing 3$ mm
nozzle 30° drill hole $\varnothing 3$ mm

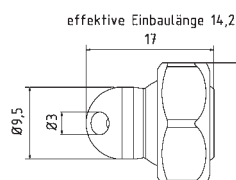

1-DU-30-EK

Düse 30° Bohrung $\varnothing 3$ mm extra kurz
nozzle 30° drill hole $\varnothing 3$ mm extra short

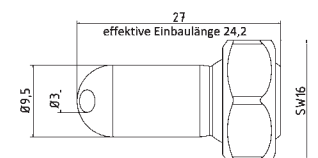

1-DU-60

Düse 60° Bohrung $\varnothing 3$ mm
nozzle 60° drill hole $\varnothing 3$ mm

Düsen / Nozzles

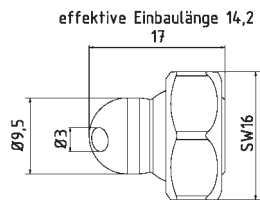

1-DU-60-EK

Düse 60° Bohrung Ø3 mm extra kurz
nozzle 60° drill hole Ø3 mm extra short

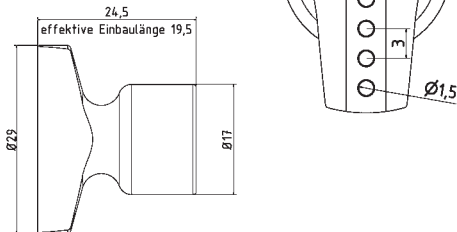

1-DU-BL

Düse Breit mit Bohrungen 9xØ1,5 mm
nozzle broadly with drillings 9xØ1,5 mm

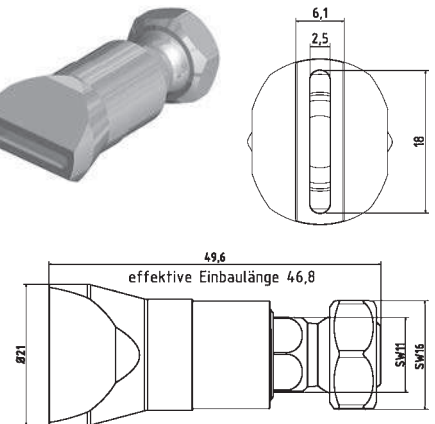

1-DU-SL-GS

Flachdüse Breit mit Schlitz 18x2,5 mm
gerader Strahl
flat nozzle broadly with slit 18x2,5 mm
straight jet

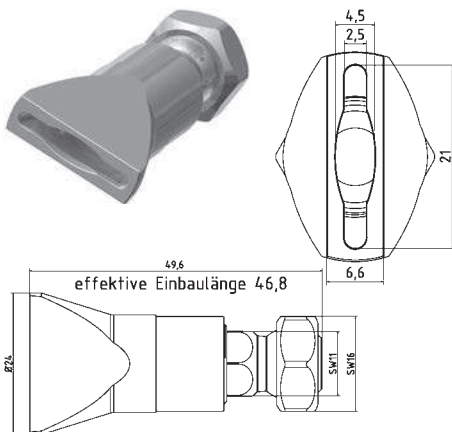

1-DU-SL-SS

Flachdüse Breit mit Schlitz 21x2,5 mm
Streustrahl
flat nozzle broadly with slit 21x2,5 mm
scattered beam

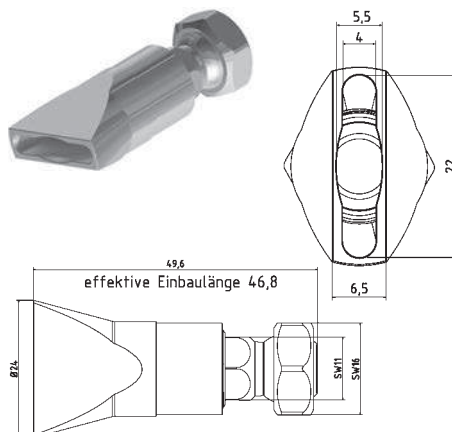

1-DU-SL-25

Flachdüse Breit mit Schlitz 22x4,0 mm
Streustrahl zum Schwemmen
flat nozzle broadly with slit 22x4,0 mm
scattered beam

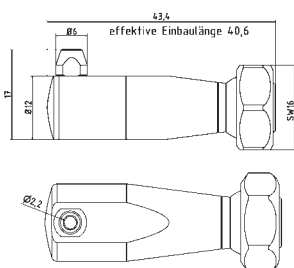

1-HA-DU

Halterung Düse klein l=40 inkl. 3 Düsen
small nozzle holder l=40 incl. 3 nozzles

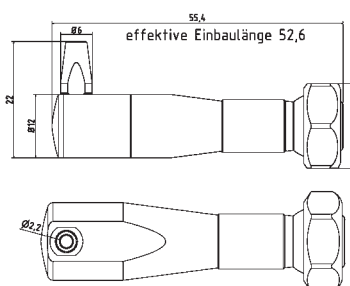

1-HA-DU-2

Halterung Düse klein l=55 inkl. 3 Düsen
small nozzle holder l=55 incl. 3 nozzles

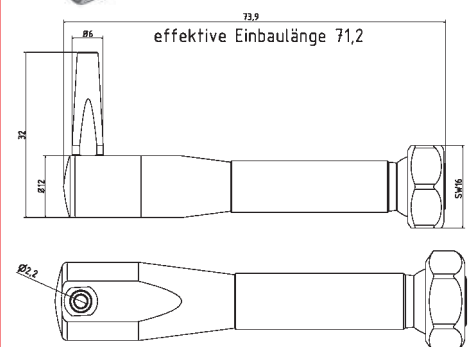
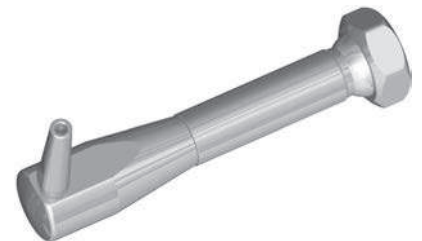

1-HA-DU-3

Halterung Düse klein l=70 inkl. 3 Düsen
small nozzle holder l=70 incl. 3 nozzles

Kunststoff-Düsen / Plastic Nozzles

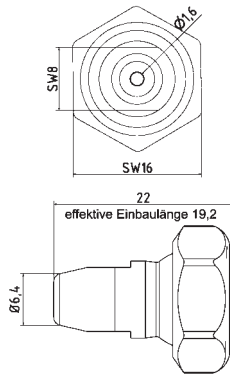

KU-1-DU-16

Kunststoff-Düse gerade Bohrung Ø 1,6 mm
plastic nozzle straight Ø 1,6 mm

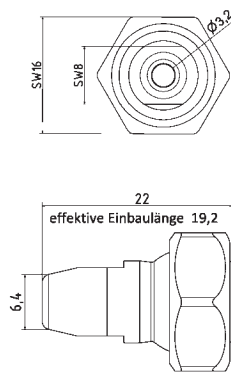

KU-1-DU-32

Kunststoff-Düse gerade Bohrung Ø 3,2 mm
plastic nozzle straight Ø 3,2 mm

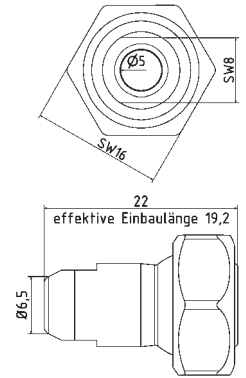

KU-1-DU-50

Kunststoff-Düse gerade Bohrung Ø 5,0 mm
plastic nozzle straight Ø 5,0 mm

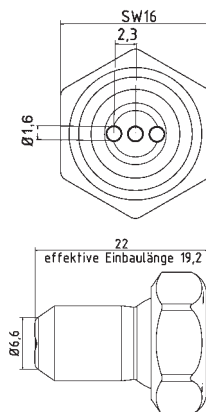

KU-1-DU-3-16

Kunststoff-Düse gerade Bohrung 3 x Ø 1,6 mm
plastic nozzle straight 3 x Ø 1,6 mm

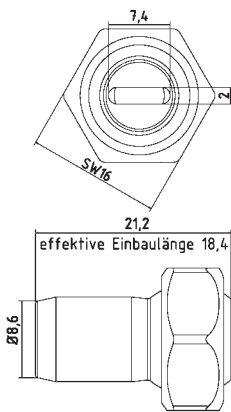

KU-1-DU-72

Kunststoff-Düse mit Schlitz 7 x 2,0 mm
plastic nozzle straight with slit 7 x 2,0 mm

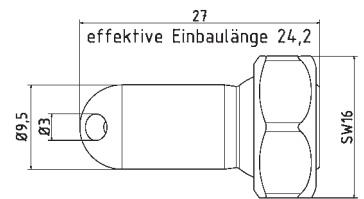

KU-1-DU-30

Kunststoff-Düse 30° Bohrung Ø 3 mm
plastic nozzle 30° drill hole Ø 3 mm

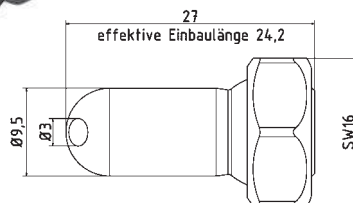

KU-1-DU-60

Kunststoff-Düse 60° Bohrung Ø 3 mm
plastic nozzle 60° drill hole Ø 3 mm

Zubehör / Accessories

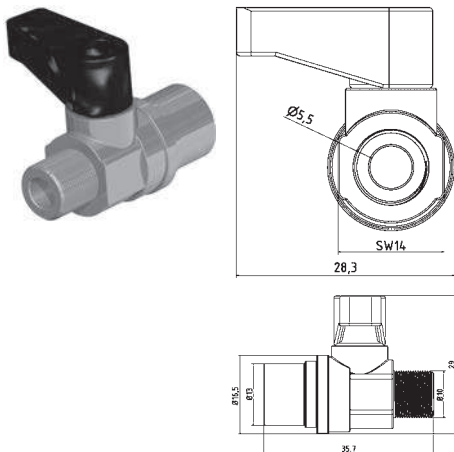

KH-18
Mini-Kugelhahn G1/8" Messing Verchromt
mini ball valve thread 1/8" brass chrome-plated

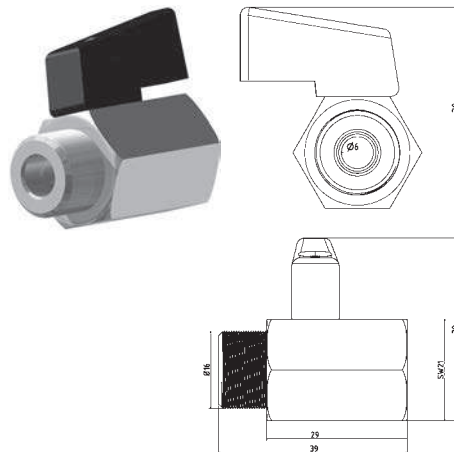

KH-14
Mini-Kugelhahn G1/4" Messing Verchromt
mini ball valve thread 1/4" brass chrome-plated

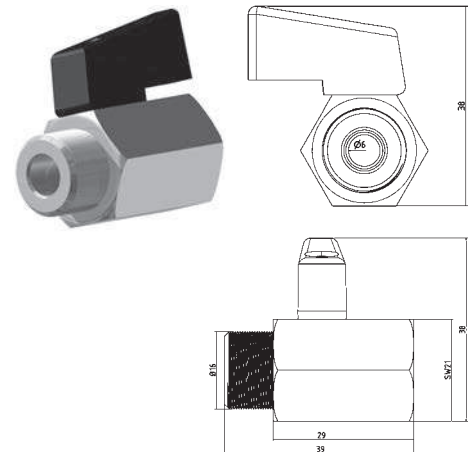

KH-14-SS
Mini-Kugelhahn G1/4" Edelstahl
mini ball valve thread 1/4" stainless steel



SW-11
Schlüssel aus Stahl SW11
open end wrench SW11



SW-16
Schlüssel aus Stahl SW16
open end wrench SW16

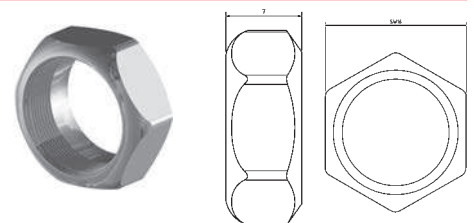

1-MU
Mutter Standard
screw nut (default)

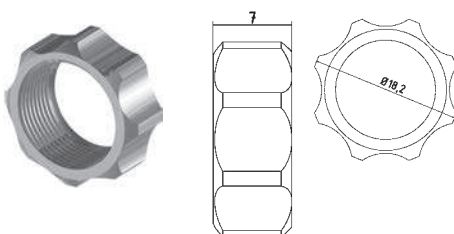

1-MU-HA
Mutter für Handverstellung
screw nut (hand feed)

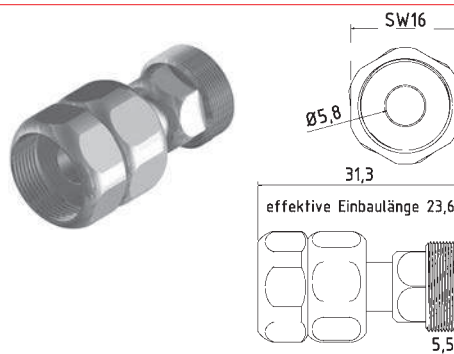

1-FP
Zwischenelement mit fester Position
(Schnellkupplung)
*Intermediate element with fixed position
(quick coupling)*

Grundset / Basic Set

1-GS
Grundset Typ1 1/4" System bestehend aus:
basic set Typ1 1/4" system l=220 mm
6 x 1-GE, 1 x 1-GE-2, 1 x 1-GE-3, 1 x 1-AD-18,
1 x 1-AD-14, 1 x 1-DU-16, 1 x 1-DU-32

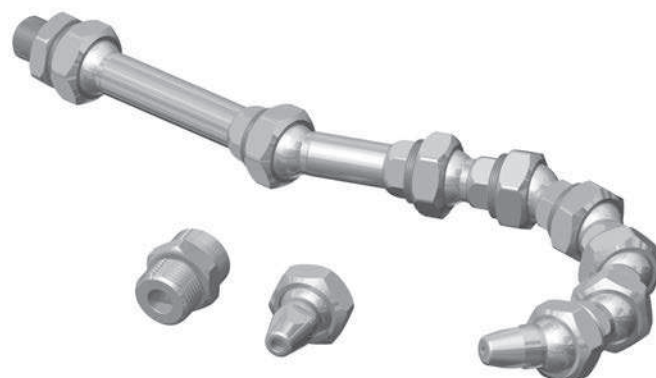

ALEXANDER SIFTAR KG
TEL. 02235 73084

was@siftar.com